



General VRLA Battery

6FM70G (12V70Ah)

The LONGWAY General Series middle batteries (more than 24Ah) are designed and developed using AGM technology and valve controlled sealing technology. They can meet conventional performance requirements, with a designed float charging life of over 8 years. The valve controlled non-spillable structure design allows safe use in any direction and is certified by sea and air freight. The battery performance also meets international standards. such as IEC60896-2012, UL1989.etc.



General Feature

- High reliability, safe without leakage, can be used in any position
- Excellent recovery performance after deep discharge
- Environmentally friendly products.
Meet EU battery directive RoHS and REACH standards
- Maintenance free
- Widely applicable temperature range, can be used at -20°C~60°C
- Low self-discharge rate. The average monthly self-discharge rate of the battery is less than 2.5%
(It is recommended to recharge after storage for 6 months or before use)

Applications

- Emergency lights; Alarm system
- Electrical test equipment; communication Equipment
- Uninterruptible power supply; Fire & Security
- Electric toys; Control instruments
- Portable Movie & Video lights
- Electric tools; Solar system
- Robots and control machines and other

Performance

Nominal Voltage	12V (6cells)
Capacity	@25°C
10hr Rate (7.00A)	70.0Ah @ to 1.75V/cell
5hr Rate (12.7A)	63.8Ah @ to 1.70V/cell
3hr Rate (17.5 A)	52.5Ah @ to 1.60V/cell
Weight	Approx (21.1±3%)kg (46.52lbs)
Internal Resistance	Approx 6.80mΩ fully charged @25°C
Maximum Discharge Current	350A(3sec)
Terminal	I4-1
Operating Temperature Range	Discharge:-20°C~60°C;Charge:0°C~50°C Storage:-20°C~40°C
Container Material	ABS(UL94 HB)/UL94-V0 Optional

Dimensions

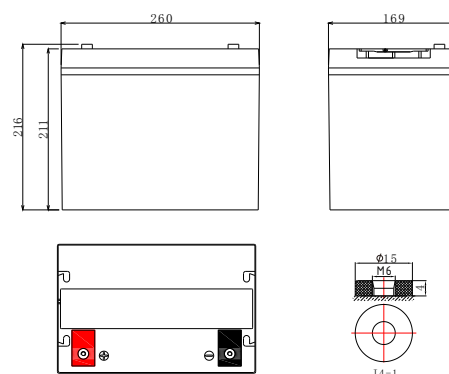

Length	260mm	10.2inch
Width	169mm	6.65inch
Height	211mm	8.31inch
Total height	216mm	8.50inch

Battery use

Cycle use

1. Limit the initial charging current to no more than 17.5A
2. Keep charging voltage at 14.4-15.0V/unit.and continue charging at least 3 hours after the charging current reduces to 1.4A to ensure full charge
3. The compensation coefficient of charging voltage and temperature is -5mv/cell/°C

Float use

1. Limit the initial charging current to no more than 17.5A
2. Keep charging voltage at 13.5-13.8V/unit.When the voltage reaches the constant voltage,the current gradually decreases until the battery is fully charged and continues to charge
3. The compensation coefficient of charging voltage and temperature is -3mv/cell/°C



Kaiying Power Supply & Electrical Equip Co., Ltd Email: sales@longwaybattery.com
 Tel:0595-68782266 Fax:0595-68782222 Website: <http://www.longwaybattery.com>
 Add: Kaiying Industrial Area, Chengxiang Town, Anxi, Quanzhou, Fujian Province, China
 KY-IOP-LW12-70B B0. May 2023

Note: This information usually describes use only and is not intended to make any warranties or promises regarding the battery. Battery specifications and battery design are subject to change without prior notice. Please contact LONGWAY Battery for the latest information.



General VRLA Battery 6FM70G (12V70Ah)

Floating Charging Life VS Temperature

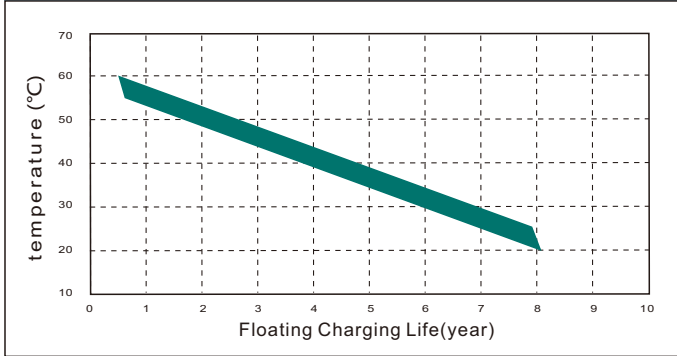

Floating Charging Characteristics Diagram

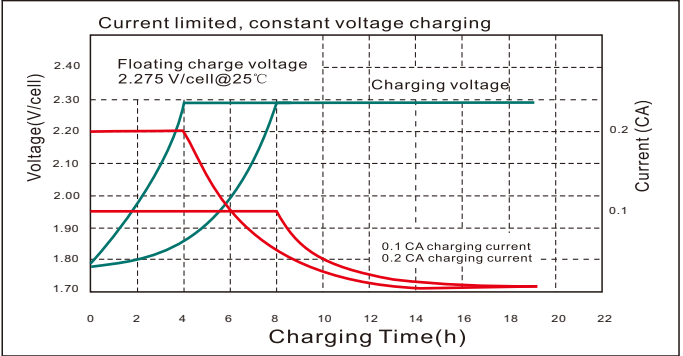

Cycle Life



Cycle charging characteristic diagram

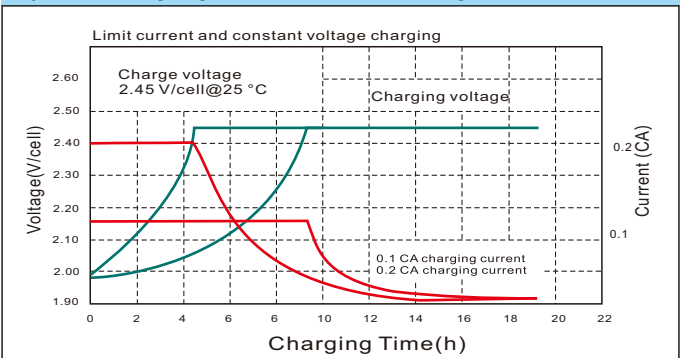

Temperature and capacity characteristics



Self-discharge characteristic

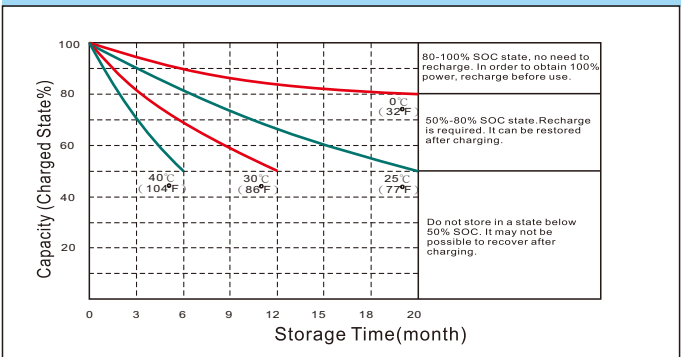

Constant current characteristics(A,25°C)

F.V/TIME	5min	10min	15min	30min	60min	90min	2h	3h	5h	10h	20h
9.6	189	161	123	72.1	39.2	24.2	17.8	12.2	8.17	7.11	3.66
9.9	183	156	120	70.7	38.4	24.0	17.7	12.2	8.13	7.07	3.64
10.2	180	153	118	69.2	37.6	23.8	17.5	12.0	8.10	7.04	3.63
10.5	169	148	114	67.1	36.5	23.6	17.3	11.9	8.07	7.02	3.62
10.8	155	144	112	65.8	35.8	23.3	17.2	11.8	8.05	7.00	3.61

Constant power discharge characteristic (W,25°C)

F.V/TIME	5min	10min	15min	30min	60min	90min	2h	3h	5h	10h	20h
9.6	2041	1758	1397	809.0	446.9	279.7	208.9	144.4	98.05	84.83	43.91
9.9	1980	1705	1318	792.8	437.9	278.4	207.9	143.7	97.57	84.42	43.69
10.2	1939	1670	1291	776.6	429.0	275.6	205.8	142.3	97.18	84.08	43.52
10.5	1827	1617	1251	752.3	415.6	272.8	203.7	140.9	96.89	83.83	43.39
10.8	1674	1570	1227	737.8	407.6	270.1	201.7	139.5	96.60	83.58	43.26



Kaiying Power Supply & Electrical Equip Co., Ltd Email: sales@longwaybattery.com
 Tel:0595-68782266 Fax:0595-68782222 Website: <http://www.longwaybattery.com>
 Add: Kaiying Industrial Area, Chengxiang Town, Anxi, Quanzhou, Fujian Province, China
 KY-IOP-LW12-70B B0. May 2023

Note: This information usually describes use only and is not intended to make any warranties or promises regarding the battery. Battery specifications and battery design are subject to change without prior notice. Please contact LONGWAY Battery for the latest information.