



General VRLA Battery

6FM28G (12V28Ah)

The LONGWAY General Series middle batteries (more than 24Ah) are designed and developed using AGM technology and valve controlled sealing technology. They can meet conventional performance requirements, with a designed float charging life of over 8 years. The valve controlled non-spillable structure design allows safe use in any direction and is certified by sea and air freight. The battery performance also meets international standards. such as IEC60896-2012, UL1989.etc.



General Feature

- High reliability, safe without leakage, can be used in any position
- Excellent recovery performance after deep discharge
- Environmentally friendly products.
Meet EU battery directive RoHS and REACH standards
- Maintenance free
- Widely applicable temperature range, can be used at -20 °C~60°C
- Low self-discharge rate. The average monthly self-discharge rate of the battery is less than 2.5%
(It is recommended to recharge after storage for 6 months or before use)

Applications

- Emergency lights; Alarm system
- Electrical test equipment; communication Equipment
- Uninterruptible power supply; Fire & Security
- Electric toys; Control instruments
- Portable Movie & Video lights
- Electric tools; Solar system
- Robots and control machines and other

Performance

Nominal Voltage	12V (6cells)
Capacity	@25°C
10hr Rate (2.60A)	26.0Ah @ to 1.75V/cell
5hr Rate (4.40A)	22.0Ah @ to 1.70V/cell
3hr Rate (6.50 A)	19.5Ah @ to 1.60V/cell
Weight	Approx (8.30±3%)kg (18.29lbs)
Internal Resistance	Approx 10.0mΩ fully charged @25°C
Maximum Discharge Current	180A(3sec)
Terminal	F9
Operating Temperature Range	Discharge:-20°C~60°C; Charge:0°C~50°C Storage:-20°C~40°C
Container Material	ABS(UL94 HB)/UL94-V0 Optional

Dimensions

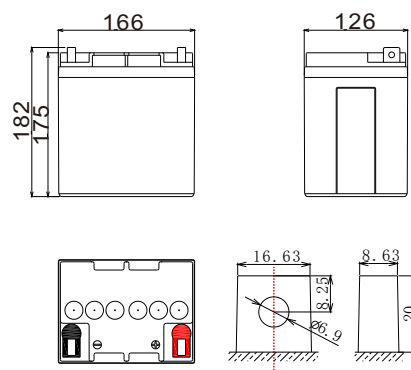

Length	166mm	6.54inch
Width	126mm	4.96inch
Height	175mm	6.89inch
Total height	182mm	7.16inch

Battery use

Cycle use

1. Limit the initial charging current to no more than 7A
2. Keep charging voltage at 14.4-15.0V/unit.and continue charging at least 3 hours after the charging current reduces to 0.56A to ensure full charge
3. The compensation coefficient of charging voltage and temperature is -5mv/cell/°C

Float use

1. Limit the initial charging current to no more than 7A
2. Keep charging voltage at 13.5-13.8V/unit.When the voltage reaches the constant voltage,the current gradually decreases until the battery is fully charged and continues to charge
3. The compensation coefficient of charging voltage and temperature is -3mv/cell/°C



Kaiying Power Supply & Electrical Equip Co., Ltd Email: sales@longwaybattery.com
 Tel:0595-68782266 Fax:0595-68782222 Website: <http://www.longwaybattery.com>
 Add: Kaiying Industrial Area, Chengxiang Town, Anxi, Quanzhou, Fujian Province, China
 KY-IOP-LW12-28A B0. May 2023

Note: This information usually describes use only and is not intended to make any warranties or promises regarding the battery. Battery specifications and battery design are subject to change without prior notice. Please contact LONGWAY Battery for the latest information.



General VRLA Battery

6FM28G (12V28Ah)

Floating Charging Life VS Temperature

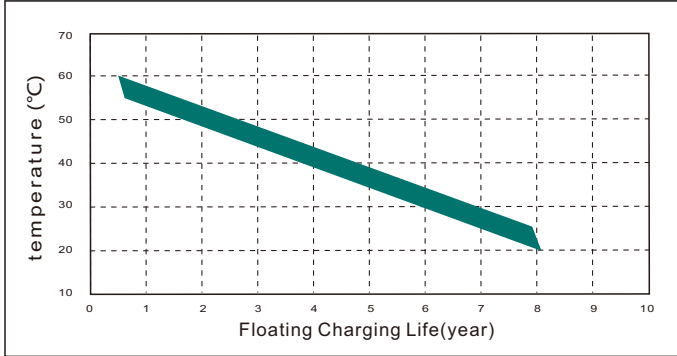

Floating Charging Characteristics Diagram

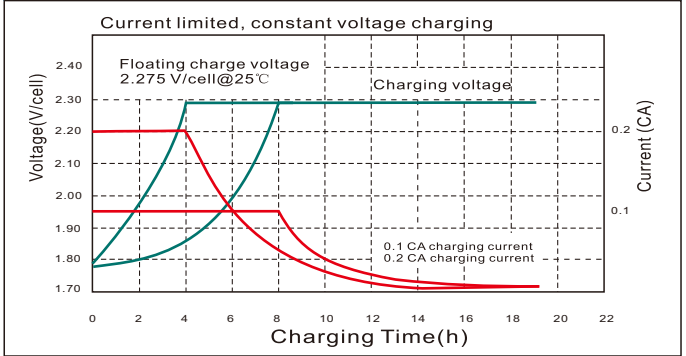

Cycle Life

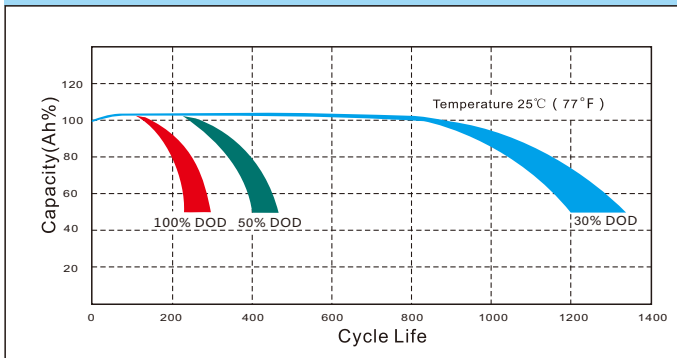

Cycle charging characteristic diagram

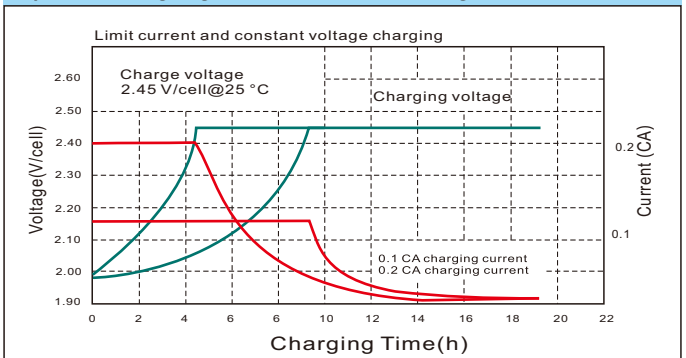

Temperature and capacity characteristics

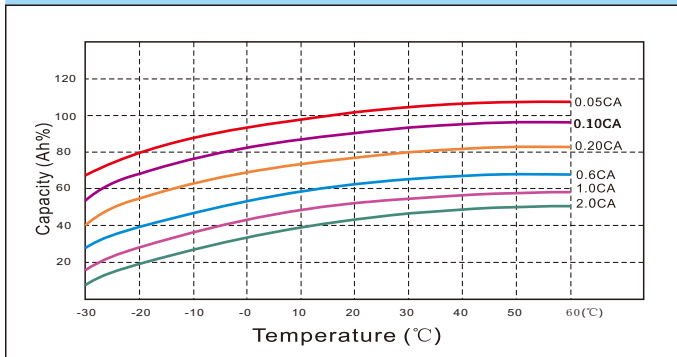

Self-discharge characteristic

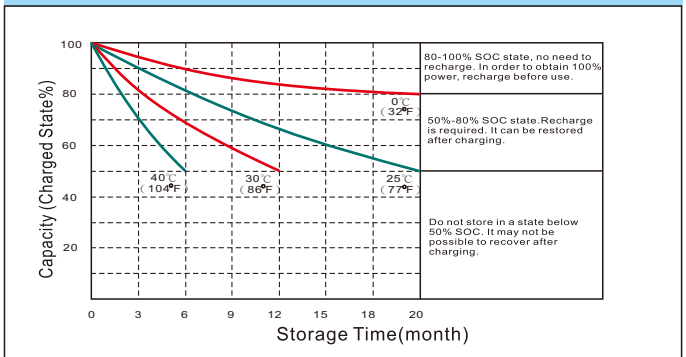

Constant current characteristics(A,25°C)

F.V/TIME	5min	10min	15min	30min	60min	90min	2h	3h	5h	10h	20h
9.60	98.8	67.6	49.4	28.6	16.9	12.09	9.50	6.65	4.49	2.53	1.32
9.90	95.8	65.6	47.9	27.7	16.4	11.85	9.41	6.58	4.44	2.52	1.31
10.2	93.9	64.2	47.4	27.5	16.2	11.61	9.36	6.55	4.42	2.51	1.31
10.5	90.9	62.2	45.4	26.3	15.5	11.36	9.27	6.49	4.38	2.50	1.30
10.8	88.2	60.4	45.1	26.1	15.4	11.12	9.17	6.42	4.33	2.50	1.30

Constant power discharge characteristic (W,25°C)

F.V/TIME	5min	10min	15min	30min	60min	90min	2h	3h	5h	10h	20h
9.60	1103	763	563	328	196	141.5	111.2	79.0	53.6	30.4	15.8
9.90	1070	740	546	318	190	138.6	110.1	78.2	53.0	30.3	15.8
10.2	1047	724	541	315	188	135.8	109.5	77.8	52.8	30.1	15.7
10.5	1014	702	518	302	180	133.0	108.4	77.1	52.2	30.0	15.6
10.8	985	681	514	299	178	130.1	107.3	76.3	51.7	30.0	15.6



Kaiying Power Supply & Electrical Equip Co., Ltd Email: sales@longwaybattery.com
 Tel:0595-68782266 Fax:0595-68782222 Website: <http://www.longwaybattery.com>
 Add: Kaiying Industrial Area, Chengxiang Town, Anxi, Quanzhou, Fujian Province, China
 KY-IOP-LW12-28A B0. May 2023

Note: This information usually describes use only and is not intended to make any warranties or promises regarding the battery. Battery specifications and battery design are subject to change without prior notice. Please contact LONGWAY Battery for the latest information.