



# Electrical toy car battery series

## 6FM7 (12V7Ah)

LONGWAY Brand toy car batteries are specially designed and developed for children's electric strollers, electric scooters and other toy cars. It uses special lead paste formula and Internalized formation production process to ensure that the battery has the advantages of long cycle life, low self-discharge rate and strong storage capacity. Products meet the requirements of IEC and DOE energy efficiency standards, pass UL, CE, RoHS certification, and can be shipped by sea or air.



### General Feature

- High reliability, safe without leakage, can be used in any position
- Excellent recovery performance after deep discharge
- Environmentally friendly products  
Meet EU battery directive RoHS and REACH standards
- Maintenance free
- Widely applicable temperature range, can be used at -20°C~60°C
- Long Storage time. Battery with full state of charge under room temperature, after 6-12 months storage, it can be used & recovered (It is recommended to recharge after storage for 6 months or before use)

### Applications

- Children's electric car with three-wheels
- Children's electric cars
- Children's drift cars
- Children's electric karts
- Electric scooter
- Electric balance car
- And other electric toys, electric tools etc

### Performance

Nominal Voltage	12V (6cell)
Capacity	@25°C
20hr Rate (0.35A)	7.35Ah @ to 1.75V/cell
3hr Rate (1.75A)	5.25Ah @ to 1.70V/cell
27min Rate (7.00A)	3.73Ah @ to 1.60V/cell
Weight	Approx (2.01 ± 3%)kg (4.43lbs)
Internal Resistance	Approx 23.5mΩ fully charged @25°C
Maximum Discharge Current	70A(3sec)
Terminal	F1/F2
Operating Temperature Range	Discharge:-20°C~60°C; Charge:0°C~50°C Storage:-20°C~40°C
Container Material	ABS(UL94 HB)/UL94-V0 Optional

### Dimensions

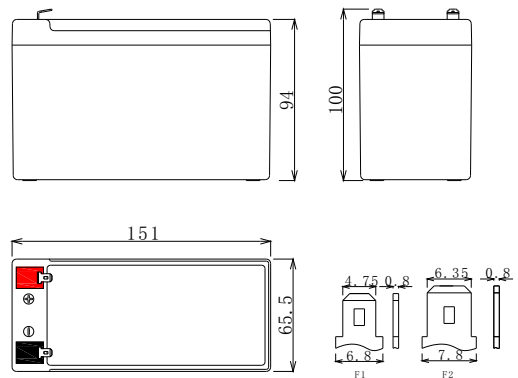

Lenght	151.0mm	5.94inch
Width	65.5mm	2.58inch
Height	94.0mm	3.70inch
Total height	100.0mm	3.94inch

### Battery use

#### Cycle use

- 1.Limit the initial charging current to no more than 2.10A
- 2.Keep charging voltage at 14.40-15.00V/unit, and continue charging at least 3 hours after the charging current reduces to 0.14A to ensure full charge
- 3.The compensation coefficient of charging voltage and temperature is -5mv/cell /°C

#### Float use

- 1.Limit the initial charging current to no more than 2.10A
2. Keep charging voltage at 13.50-13.80V/unit. When the voltage reaches the constant voltage the current gradually decreases until the battery is fully charged and continues to charge
- 3.The compensation coefficient of charging voltage and temperature is -3mv/cell /°C



Kaiying Power Supply & Electrical Equip Co., Ltd Email: [sales@longwaybattery.com](mailto:sales@longwaybattery.com)  
Tel:0595-68782266 Fax:0595-68782222 Website: <http://www.longwaybattery.com>  
Add: Kaiying IndustrialArea, Chengxiang Town, Anxi, Quanzhou, Fujian Province, China  
KY-IOP-LW12-7D B0.May 2023

Note: This information usually describes use only and is not intended to make any warranties or promises regarding the battery, Battery specifications and battery design are subject to change without prior notice. Please contact LONGWAY Battery for the latest information.



# Electrical toy car battery series

## 6FM7 (12V7Ah)

### Floating Charging Life VS Temperature

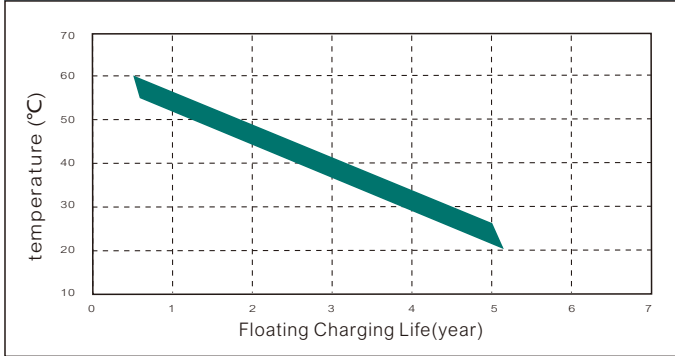

### Floating Charging Characteristics Diagram

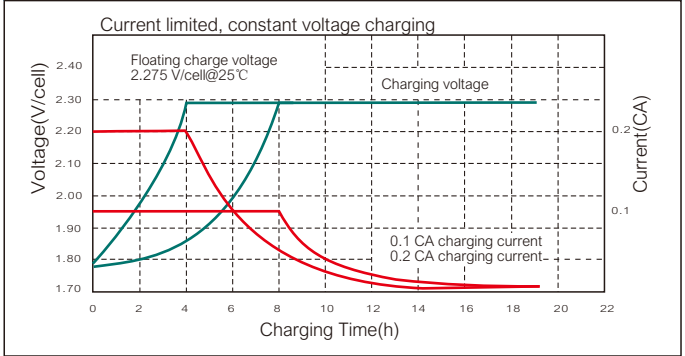

### Cycle Life

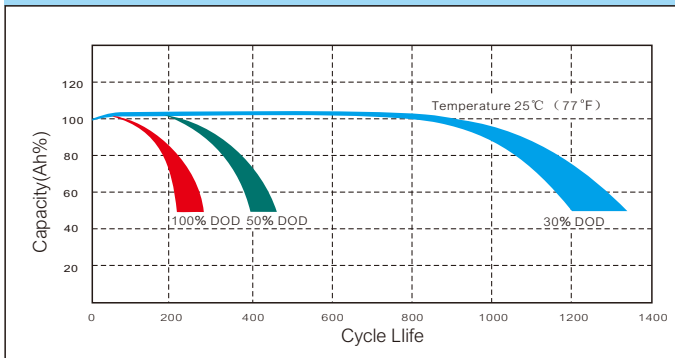

### Cycle charging characteristic diagram

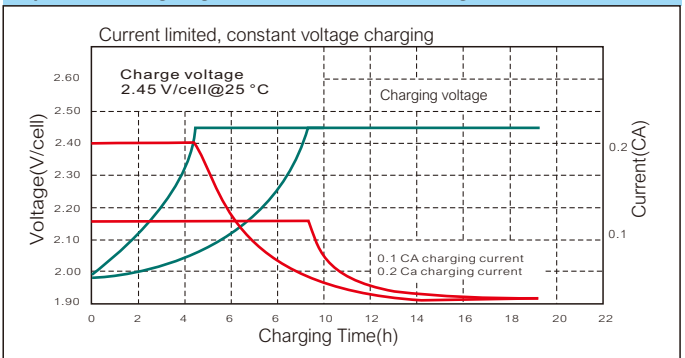

### Temperature and capacity characteristics

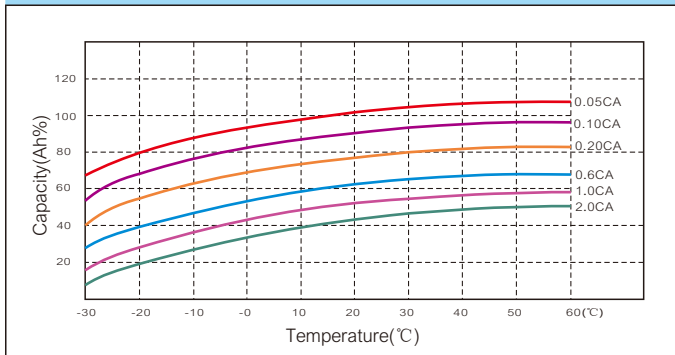

### Self-discharge characteristic

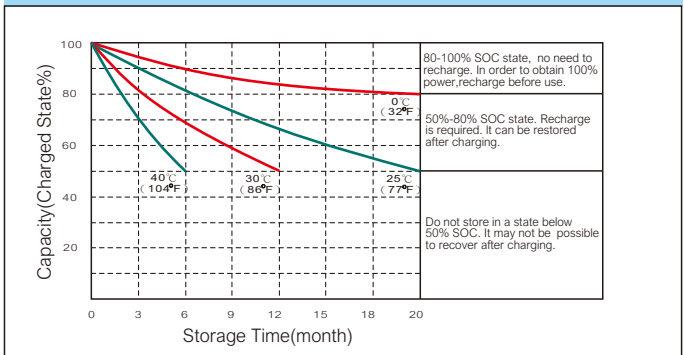

### Constant current characteristics(A,25°C )

F.V/TIME	5min	10min	15min	30min	60min	90min	2h	3h	5h	10h	20h
9.6	28.0	18.2	14.0	7.18	4.55	2.96	1.78	1.28	0.78	0.66	0.37
9.9	27.2	17.7	13.7	7.01	4.44	2.55	1.77	1.27	0.78	0.66	0.37
10.2	26.6	17.3	13.4	6.89	4.32	2.52	1.75	1.26	0.77	0.65	0.36
10.5	25.8	16.7	13.0	6.67	4.23	2.49	1.73	1.25	0.77	0.65	0.36
10.8	25.0	16.3	12.8	6.54	4.15	2.47	1.72	1.23	0.77	0.65	0.36

### Constant power discharge characteristic ( W,25°C )

F.V/TIME	5min	10min	15min	30min	60min	90min	2h	3h	5h	10h	20h
9.6	304	205	168	82.2	52.7	34.6	21.1	15.3	9.38	7.93	4.39
9.9	303	199	156	80.3	51.4	29.8	21.0	15.2	9.33	7.94	4.40
10.2	297	195	153	78.9	50.1	29.5	20.8	15.0	9.30	7.86	4.35
10.5	287	189	148	76.5	49.0	29.2	20.6	14.9	9.27	7.84	4.34
10.8	279	183	146	75.0	48.1	28.9	20.4	14.7	9.24	7.81	4.33



Kaiying Power Supply & Electrical Equip Co., Ltd Email: [sales@longwaybattery.com](mailto:sales@longwaybattery.com)  
 Tel:0595-68782266 Fax:0595-68782222 Website: <http://www.longwaybattery.com>  
 Add: Kaiying IndustrialArea, Chengxiang Town, Anxi, Quanzhou, Fujian Province, China  
 KY-IOP-LW12-7D B0.May 2023

Note: This information usually describes use only and is not intended to make any warranties or promises regarding the battery, Battery specifications and battery design are subject to change without prior notice. Please contact LONGWAY Battery for the latest information.