



Sound/Speaker System Battery

6FM28G (12V28Ah)

LONGWAY speaker batteries are designed and developed according to the characteristics of instant large current, deep discharge, easy over-discharge and high-frequency vibration required in the use of speaker. The product has the advantages of long cycle life, good performance of large current discharge, low self-discharge rate, strong recovery ability of over-discharge, strong anti-vibration ability, etc., which can meet the special performance requirements of speaker batteries. Products pass UL, CE, RoHS certification, and can be shipped by sea or air.



General Feature

- High reliability, safe without leakage, can be used in any position
- Excellent recovery performance after deep discharge
- Environmentally friendly products
Meet EU battery directive RoHS and REACH standards
- Maintenance free
- Widely applicable temperature range, can be used at -20°C~60°C
- Low self-discharge rate. The average monthly self-discharge rate of the battery is less than 2.5%
(It is recommended to recharge after storage for 6 months or before use)

Applications

- Outdoor battery speaker
- Portable video speaker
- Outdoor song on-demand stereo
- Wireless Bluetooth speaker
- Wireless line array speaker
- Square dance speaker
- And company meeting, wedding hosting, outdoor activities and other audio

Performance

Nominal Voltage	12V (6cell)
Capacity	@25°C
20hr Rate (2.80A)	28.0Ah @ to 1.75V/cell
5hr Rate (4.76A)	23.8Ah @ to 1.70V/cell
3hr Rate (7.00A)	21.0Ah @ to 1.60V/cell
Weight	Approx (8.30 ± 3%)kg (18.29lbs)
Internal Resistance	Approx 10.0mΩ fully charged @25°C
Maximum Discharge Current	180A(3sec)
Terminal	F9
Operating Temperature Range	Discharge:-20°C~60°C; Charge:0°C~50°C Storage:-20°C~40°C
Container Material	ABS(UL94 HB)/UL94-V0 Optional

Dimensions

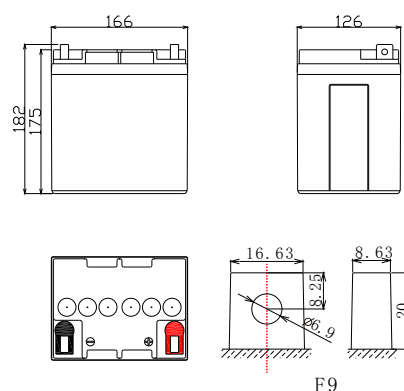

Length	166mm	6.54inch
Width	126mm	4.96inch
Height	175mm	6.89inch
Total height	182mm	7.16inch

Battery use

Cycle use

- 1.Limit the initial charging current to no more than 7.00A
- 2.Keep charging voltage at 14.40-15.00 V/unit, and continue charging at least 3 hours after the charging current reduces to 0.56A to ensure full charge
- 3.The compensation coefficient of charging voltage and temperature is -5mv/cell / °C

Float use

- 1.Limit the initial charging current to no more than 7.00A
2. Keep charging voltage at 13.50-13.80 V/unit. When the voltage reaches the constant voltage the current gradually decreases until the battery is fully charged and continues to charge
- 3.The compensation coefficient of charging voltage and temperature is -3mv/cell / °C



Kaiying Power Supply & Electrical Equip Co., Ltd Email: sales@longwaybattery.com
Tel:0595-68782266 Fax:0595-68782222 Website: <http://www.longwaybattery.com>
Add: Kaiying Industrial Area, Chengxiang Town, Anxi, Quanzhou, Fujian Province, China
KY-IOP-LW12-28D B0.May 2023

Note: This information usually describes use only and is not intended to make any warranties or promises regarding the battery, Battery specifications and battery design are subject to change without prior notice. Please contact LONGWAY Battery for the latest information



Sound/Speaker System Battery

6FM28G (12V28Ah)

Floating Charging Life VS Temperature

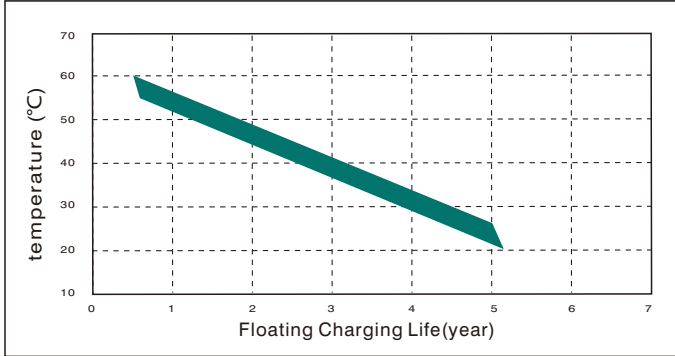

Floating Charging Characteristics Diagram

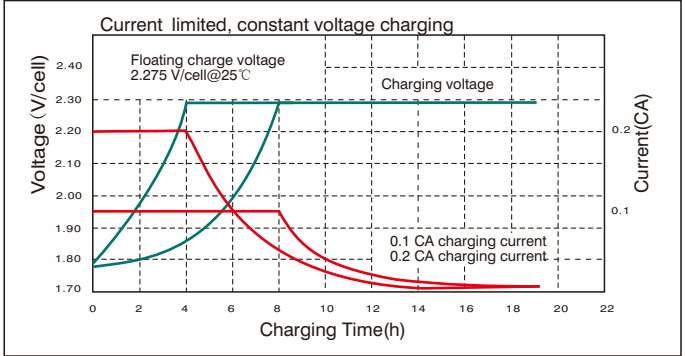

Cycle Life

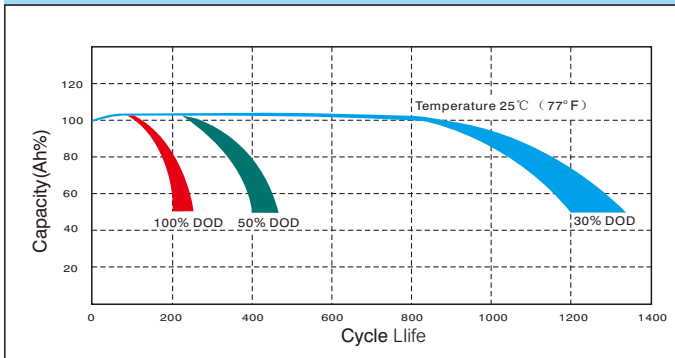

Cycle charging characteristic diagram

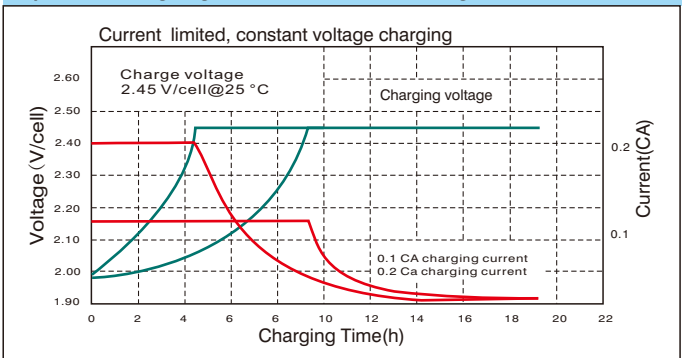

Temperature and capacity characteristics

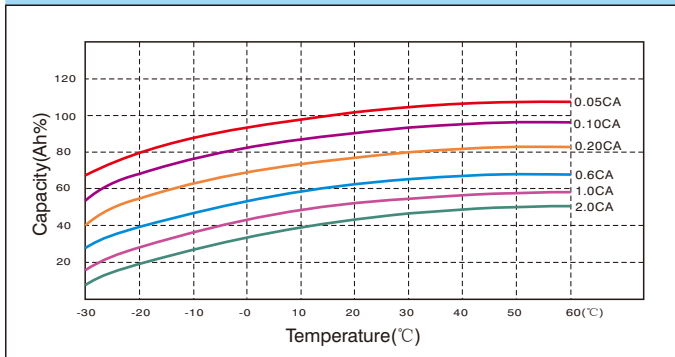

Self-discharge characteristic

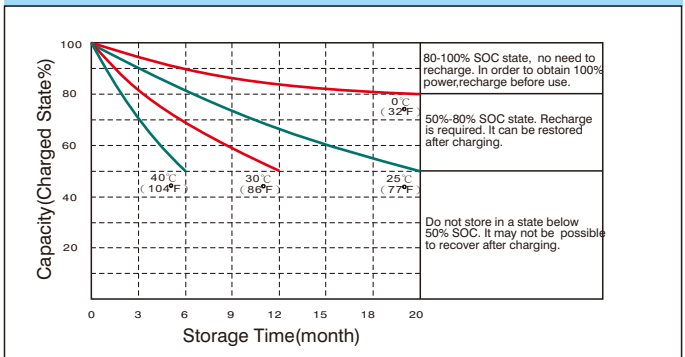

Constant current characteristics(A,25°C)

F.V/TIME	5min	10min	15min	30min	60min	90min	2h	3h	5h	10h	20h
9.60	75.6	64.4	49.0	28.8	15.7	9.66	7.11	4.89	3.27	2.84	1.46
9.90	73.3	62.5	48.0	28.3	15.4	9.62	7.07	4.86	3.25	2.83	1.46
10.2	71.8	61.2	47.0	27.7	15.1	9.52	7.00	4.82	3.24	2.82	1.45
10.5	67.7	59.2	45.6	26.8	14.6	9.42	6.93	4.77	3.23	2.81	1.45
10.8	62.0	57.5	44.7	26.3	14.3	9.33	6.86	4.72	3.22	2.80	1.44

Constant power discharge characteristic (W,25°C)

F.V/TIME	5min	10min	15min	30min	60min	90min	2h	3h	5h	10h	20h
9.60	816	703	559	324	179	111.9	83.6	57.8	39.2	33.9	17.6
9.90	792	682	527	317	175	111.3	83.1	57.5	39.0	33.8	17.5
10.2	776	668	516	311	172	110.2	82.3	56.9	38.9	33.6	17.4
10.5	731	647	500	301	166	109.1	81.5	56.4	38.8	33.5	17.4
10.8	670	628	491	295	163	108.0	80.7	55.8	38.6	33.4	17.3



Kaiying Power Supply & Electrical Equip Co., Ltd Email: sales@longwaybattery.com
 Tel:0595-68782266 Fax:0595-68782222 Website: <http://www.longwaybattery.com>
 Add: Kaiying IndustrialArea, Chengxiang Town, Anxi, Quanzhou, Fujian Province, China
 KY-IOP-LW12-28D B0.May 2023

Note: This information usually describes use only and is not intended to make any warranties or promises regarding the battery, Battery specifications and battery design are subject to change without prior notice. Please contact LONGWAY Battery for the latest information