



General VRLA Battery

6FM1.2 (12V1.2Ah)

The LONGWAY General Series small batteries (less than 24Ah) are designed and developed using AGM technology and valve controlled sealing technology. They can meet conventional performance requirements, with a designed float charging life of over 5 years. The valve controlled non-spillable structure design allows safe use in any direction and is certified by sea and air freight. The battery performance also meets international standards, such as IEC61056-2012, JIS C8702-1-2003, UL1989, etc.



General Feature

- High reliability, safe without leakage, can be used in any position
- Excellent recovery performance after deep discharge
- Environmentally friendly products.
Meet EU battery directive RoHS and REACH standards
- Maintenance free
- Widely applicable temperature range, can be used at -20 °C~60°C
- Low self-discharge rate. The average monthly self-discharge rate of the battery is less than 2.5%
(It is recommended to recharge after storage for 6 months or before use)

Applications

- Emergency lights; Alarm system
- Electrical test equipment; communication Equipment
- Uninterruptible power supply; Fire & Security
- Electric toys; Control instruments
- Portable Movie & Video lights
- Electric tools; Solar system
- Robots and control machines and other

Performance

Nominal Voltage	12V (6cells)
Capacity	@25°C
20hr Rate (0.06A)	1.38Ah @ to 1.75V/cell
3hr Rate (0.30A)	0.90Ah @ to 1.70V/cell
27min Rate (1.20A)	0.70Ah @ to 1.60V/cell
Weight	Approx (0.58±3%)kg (1.28lbs)
Internal Resistance	Approx 44mΩ fully charged @25°C
Maximum Discharge Current	36A(3sec)
Terminal	F1
Operating Temperature Range	Discharge:-20°C~60°C; Charge:0°C~50°C Storage:-20°C~40°C
Container Material	ABS(UL94 HB)/UL94-V0 Optional

Dimensions

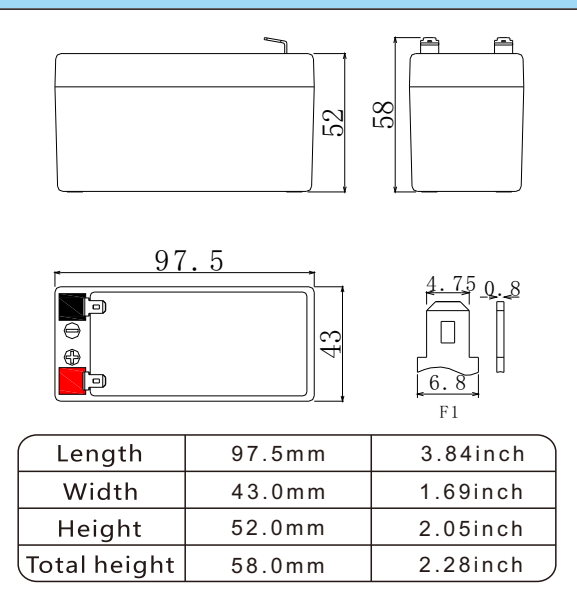

Battery use

Cycle use

1. Limit the initial charging current to no more than 0.36A
2. Keep charging voltage at 14.4-15.0V/unit, and continue charging at least 3 hours after the charging current reduces to 0.02A to ensure full charge
3. The compensation coefficient of charging voltage and temperature is -5mv/cell /°C

Float use

1. Limit the initial charging current to no more than 0.36A
2. Keep charging voltage at 13.5-13.8V/unit. When the voltage reaches the constant voltage, the current gradually decreases until the battery is fully charged and continues to charge
3. The compensation coefficient of charging voltage and temperature is -3mv/cell /°C



Kaiying Power Supply & Electrical Equip Co., Ltd Email: sales@longwaybattery.com
 Tel:0595-68782266 Fax:0595-68782222 Website: <http://www.longwaybattery.com>
 Add: Kaiying Industrial Area, Chengxiang Town, Anxi, Quanzhou, Fujian Province, China
 KY-IOP-LW12-1.2 B0. May 2023

Note: This information usually describes use only and is not intended to make any warranties or promises regarding the battery. Battery specifications and battery design are subject to change without prior notice. Please contact LONGWAY Battery for the latest information.



General VRLA Battery

6FM1.2 (12V1.2Ah)

Floating Charging Life VS Temperature

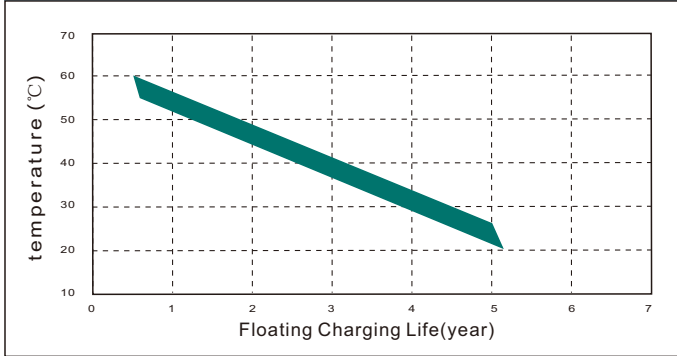

Floating Charging Characteristics Diagram

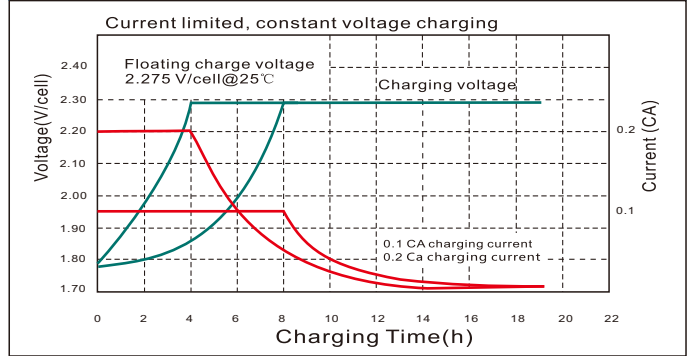

Cycle Life

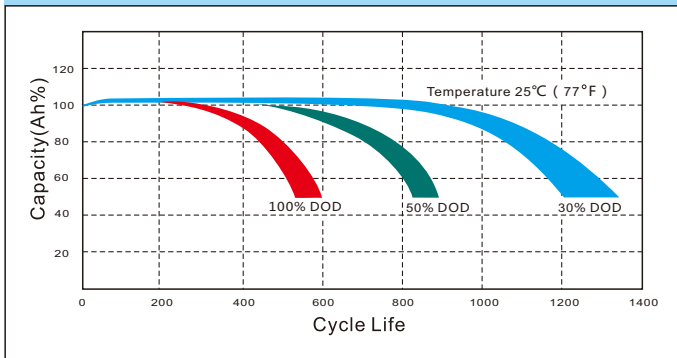

Cycle charging characteristic diagram

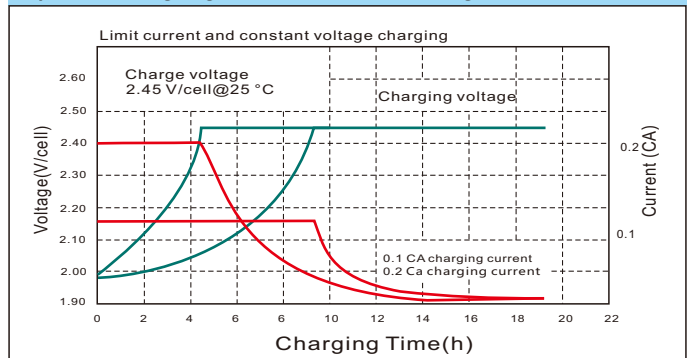

Temperature and capacity characteristics

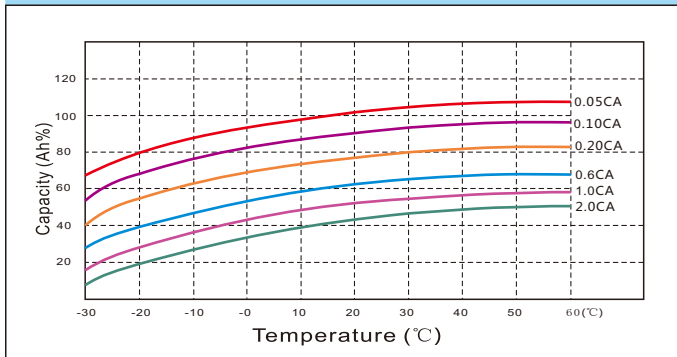

Self-discharge characteristic

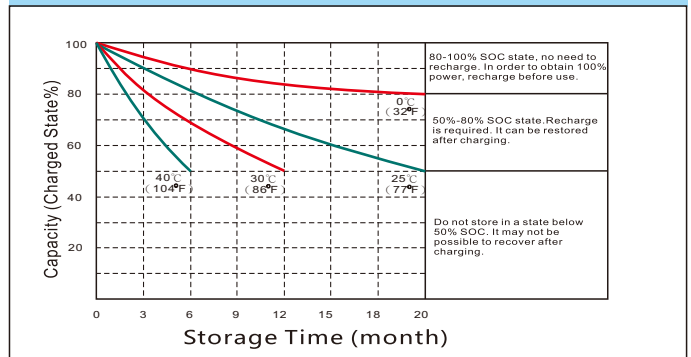

Constant current characteristics(A,25°C)

F.V/TIME	5min	10min	15min	30min	60min	90min	2h	3h	5h	10h	20h
9.6	4.68	2.88	2.4	1.38	0.81	0.56	0.44	0.34	0.22	0.13	0.07
9.9	4.54	2.79	2.33	1.34	0.79	0.55	0.43	0.34	0.22	0.13	0.07
10.2	4.45	2.74	2.3	1.32	0.78	0.54	0.43	0.34	0.22	0.13	0.07
10.5	4.31	2.65	2.21	1.27	0.75	0.53	0.43	0.33	0.21	0.13	0.07
10.8	4.18	2.57	2.19	1.26	0.74	0.52	0.42	0.33	0.21	0.13	0.07

Constant power discharge characteristic (W,25°C)

F.V/TIME	5min	10min	15min	30min	60min	90min	2h	3h	5h	10h	20h
9.6	52	32.5	27.4	15.8	9.38	6.6	5.13	4.05	2.62	1.56	0.83
9.9	51	31.5	26.5	15.3	9.1	6.47	5.08	4.01	2.59	1.56	0.83
10.2	50	30.9	26.3	15.2	9	6.33	5.05	3.99	2.58	1.55	0.83
10.5	48	29.9	25.2	14.5	8.63	6.2	5	3.95	2.55	1.54	0.82
10.8	47	29	25	14.4	8.55	6.07	4.95	3.91	2.53	1.54	0.82



Kaiying Power Supply & Electrical Equip Co., Ltd Email: sales@longwaybattery.com
 Tel:0595-68782266 Fax:0595-68782222 Website: <http://www.longwaybattery.com>
 Add: Kaiying Industrial Area, Chengxiang Town, Anxi, Quanzhou, Fujian Province, China
 KY-IOP-LW12-1.2 B0. May 2023

Note: This information usually describes use only and is not intended to make any warranties or promises regarding the battery. Battery specifications and battery design are subject to change without prior notice. Please contact LONGWAY Battery for the latest information.