



General VRLA Battery

3FM1.2 (6V1.2Ah)

The LONGWAY General Series small batteries (less than 24Ah) are designed and developed using AGM technology and valve controlled sealing technology. They can meet conventional performance requirements, with a designed float charging life of over 5 years. The valve controlled non-spillable structure design allows safe use in any direction and is certified by sea and air freight. The battery performance also meets international standards, such as IEC61056-2012, JIS C8702-1-2003, UL1989, etc.



General Feature

- High reliability, safe without leakage, can be used in any position
- Excellent recovery performance after deep discharge
- Environmentally friendly products.
Meet EU battery directive RoHS and REACH standards
- Maintenance free
- Widely applicable temperature range, can be used at -20 °C~60°C
- Low self-discharge rate. The average monthly self-discharge rate of the battery is less than 2.5%
(It is recommended to recharge after storage for 6 months or before use)

Applications

- Emergency lights; Alarm system
- Electrical test equipment; communication Equipment
- Uninterruptible power supply; Fire & Security
- Electric toys; Control instruments
- Portable Movie & Video lights
- Electric tools; Solar system
- Robots and control machines and other

Performance

| | |
|-----------------------------|---|
| Nominal Voltage | 6V (3cells) |
| Capacity | @25°C |
| 20hr Rate (0.06A) | 1.38 Ah @ to 1.75V/cell |
| 3hr Rate (0.30A) | 0.90 Ah @ to 1.70V/cell |
| 27min Rate (1.20A) | 0.70 Ah @ to 1.60V/cell |
| Weight | Approx (0.30±3%)kg (0.66lbs) |
| Internal Resistance | Approx 22.0mΩfully charged @25°C |
| Maximum Discharge Current | 30A(3sec) |
| Terminal | F1 |
| Operating Temperature Range | Discharge:-20°C~60°C; Charge:0°C~50°C Storage:-20°C~40°C |
| Container Material | ABS(UL94 HB)/UL94-V0 Optional |

Dimensions

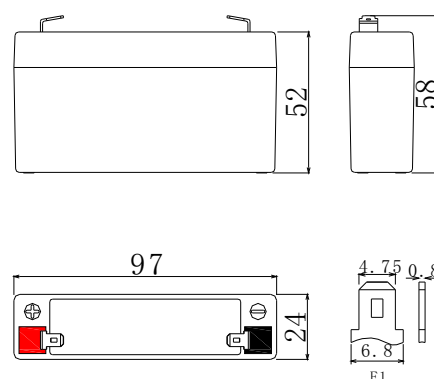

| | | |
|--------------|--------|----------|
| Length | 97.0mm | 3.82inch |
| Width | 24.0mm | 0.94inch |
| Height | 52.0mm | 2.05inch |
| Total height | 58.0mm | 2.28inch |

Battery use

Cycle use

1. Limit the initial charging current to no more than 0.6A
2. Keep charging voltage at 7.20-7.50V/unit, and continue charging at least 3 hours after the charging current reduces to 0.04A to ensure full charge
3. The compensation coefficient of charging voltage and temperature is -5mv/cell /°C

Float use

1. Limit the initial charging current to no more than 0.6A
2. Keep charging voltage at 6.75-6.90V/unit. When the voltage reaches the constant voltage, the current gradually decreases until the battery is fully charged and continues to charge
3. The compensation coefficient of charging voltage and temperature is -3mv/cell /°C



Kaiying Power Supply & Electrical Equip Co., Ltd Email: sales@longwaybattery.com
 Tel:0595-68782266 Fax:0595-68782222 Website: <http://www.longwaybattery.com>
 Add: Kaiying Industrial Area, Chengxiang Town, Anxi, Quanzhou, Fujian Province, China
 KY-IOP-LW6-1.2 B0. May 2023

Note: This information usually describes use only and is not intended to make any warranties or promises regarding the battery. Battery specifications and battery design are subject to change without prior notice. Please contact LONGWAY Battery for the latest information.



General VRLA Battery

3FM1.2 (6V1.2Ah)

Floating Charging Life VS Temperature

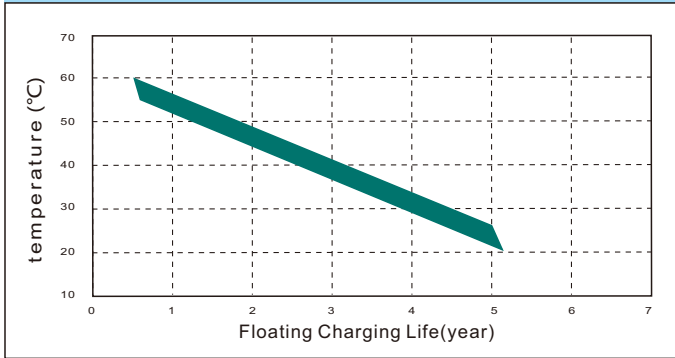

Floating Charging Characteristics Diagram

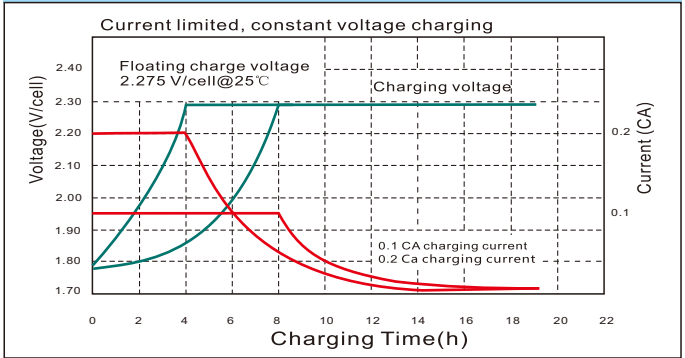

Cycle Life

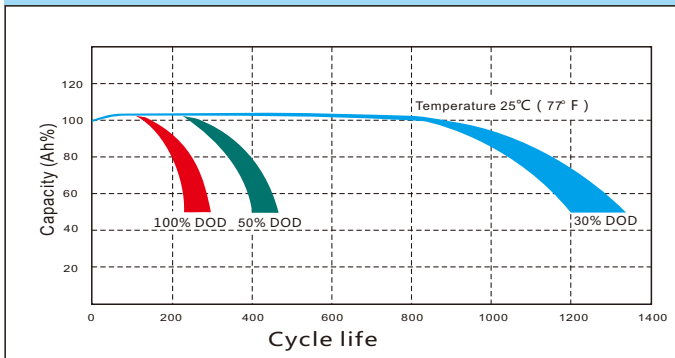

Cycle charging characteristic diagram

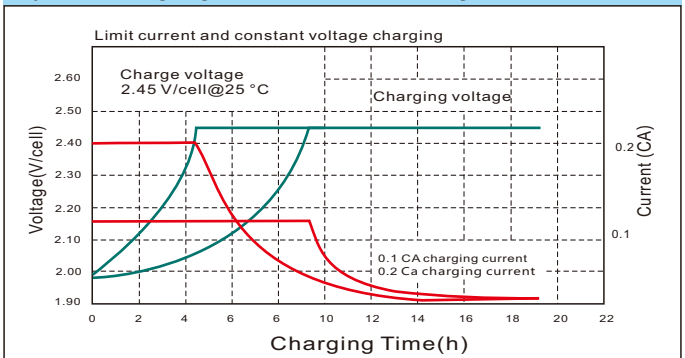

Temperature and capacity characteristics

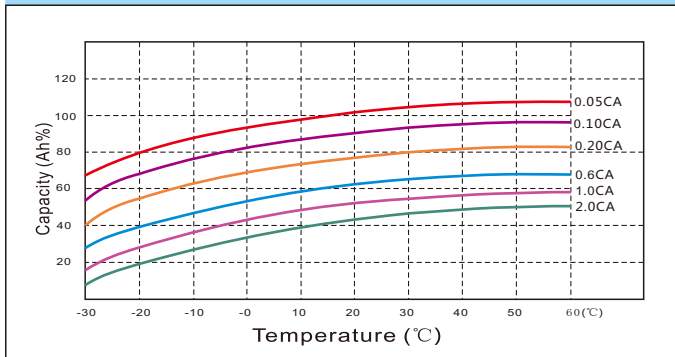

Self-discharge characteristic

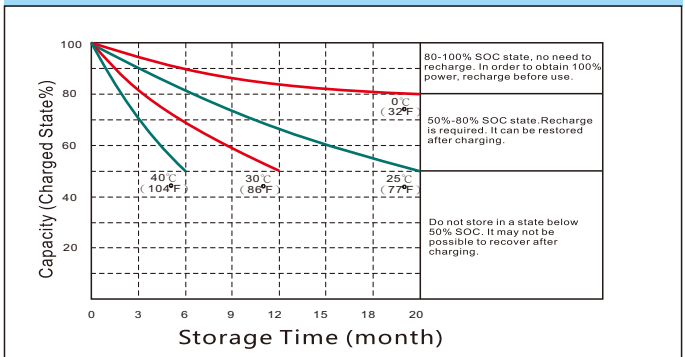

Constant current characteristics(A,25°C)

| F.V/TIME | 5min | 10min | 15min | 30min | 60min | 90min | 2h | 3h | 5h | 10h | 20h |
|----------|------|-------|-------|-------|-------|-------|------|------|------|------|------|
| 4.80 | 6.00 | 3.84 | 2.64 | 1.54 | 0.90 | 0.62 | 0.49 | 0.37 | 0.26 | 0.14 | 0.07 |
| 4.95 | 5.82 | 3.72 | 2.56 | 1.49 | 0.87 | 0.61 | 0.48 | 0.36 | 0.25 | 0.14 | 0.07 |
| 5.10 | 5.70 | 3.65 | 2.53 | 1.47 | 0.86 | 0.60 | 0.48 | 0.36 | 0.25 | 0.14 | 0.07 |
| 5.25 | 5.52 | 3.53 | 2.43 | 1.41 | 0.83 | 0.59 | 0.48 | 0.36 | 0.25 | 0.14 | 0.07 |
| 5.40 | 5.36 | 3.43 | 2.41 | 1.40 | 0.82 | 0.57 | 0.47 | 0.35 | 0.25 | 0.14 | 0.07 |

Constant power discharge characteristic (W,25°C)

| F.V/TIME | 5min | 10min | 15min | 30min | 60min | 90min | 2h | 3h | 5h | 10h | 20h |
|----------|-------|-------|-------|-------|-------|-------|------|------|------|------|------|
| 4.80 | 33.50 | 21.70 | 15.00 | 8.80 | 5.21 | 3.65 | 2.85 | 2.17 | 1.53 | 0.87 | 0.40 |
| 4.95 | 32.50 | 21.00 | 14.60 | 8.54 | 5.05 | 3.58 | 2.82 | 2.15 | 1.51 | 0.87 | 0.40 |
| 5.10 | 31.80 | 20.60 | 14.40 | 8.45 | 5.00 | 3.50 | 2.81 | 2.14 | 1.50 | 0.86 | 0.40 |
| 5.25 | 30.80 | 19.90 | 13.80 | 8.10 | 4.79 | 3.43 | 2.78 | 2.12 | 1.49 | 0.86 | 0.40 |
| 5.40 | 29.90 | 19.30 | 13.70 | 8.03 | 4.75 | 3.36 | 2.75 | 2.10 | 1.47 | 0.86 | 0.40 |



Kaiying Power Supply & Electrical Equip Co., Ltd Email: sales@longwaybattery.com
 Tel:0595-68782266 Fax:0595-68782222 Website: <http://www.longwaybattery.com>
 Add: Kaiying Industrial Area, Chengxiang Town, Anxi, Quanzhou, Fujian Province, China
 KY-IOP-LW6-1.2 B0. May 2023

Note: This information usually describes use only and is not intended to make any warranties or promises regarding the battery. Battery specifications and battery design are subject to change without prior notice. Please contact LONGWAY Battery for the latest information.