



# Weighing Scales Battery

## 3FM1.2 (6V1.2Ah/20Hr)

LONGWAY Brand electrical scales battery series are specially designed & developed according to the characteristic of electrical scales in actual use. Adopting AGM and valve controlled sealing technology, it has the advantages of safety, reliability, without leakage, low self discharge rate, strong resistance to over discharge, and good recovery ability. Maintenance free products, certified by sea and air freight. The battery performance meets international standards, such as IEC61056-2012, JIS C8702-1-2003, UL 1989 etc.



### General Feature

- Reliable without leakage
- Super-long service life
- Low self-discharge rate & strong storage capacity
- Strong resistance to overdischarge and good recovery ability
- Environmental friendly product

### Applications

- it can be charged continuously for 48 hours without leakage, and can be used in any direction such as side, horizontal, and upside down.
- Adopt optimization design under deep discharge, and the residual capacity shall not be less than 50% of rated capacity after 96 times of 100hr full capacity cycle life.
- It still can be used normally after fully battery storage 2 years, and without affecting its service life.
- it still can be used normally after continuous storage for 120 days at 50% SOC. and without affecting its service life.
- Unique lead paste formula and plate ratio design. After the battery is discharged to 0V, the wires are directly short circuited for 3 days. After recharging, the cycle test is conducted 3 times, and the discharge capacity recovers to over 95% after 100 hours.
- Meet the RoHS and REACH standards of the EU Battery Directive.

### Performance

Nominal Voltage	6V (3cell)
Rated Capacity	@25°C
20hr Rate (0.06A)	1.38Ah @ to 1.75V/cell
100hr Rate (0.012A)	1.59Ah @ to 1.90V/cell
3hr Rate (0.30A)	0.90Ah @ to 1.60V/cell
Weight	Approx (0.30 ± 3%)kg (0.66lbs)
Internal Resistance	Approx 22.0mΩ fully charged @25°C
Maximum discharge current	30A(3sec)
Temperature range	0°C~50°C ; Storage: -20°C~40°C
Suggest charge voltage	6.90~7.20V/cell, DC voltage @25°C
Suggest charge current	0.18A
Terminal	F1

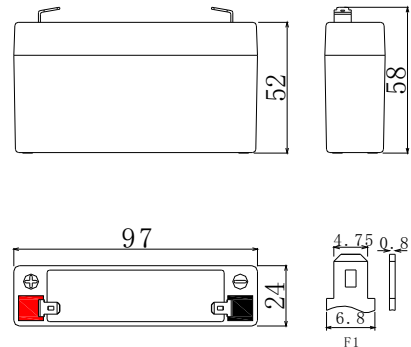

Length	97.0mm	3.82inch
Width	24.0mm	0.94inch
Height	52.0mm	2.05inch
Total height	58.0mm	2.28inch

### 100Hr discharge cycle characteristics

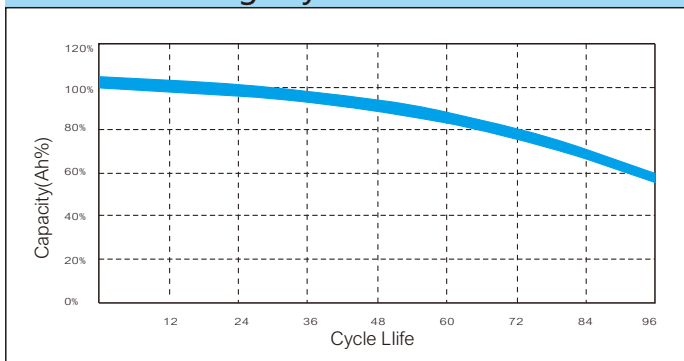

### Storage characteristics

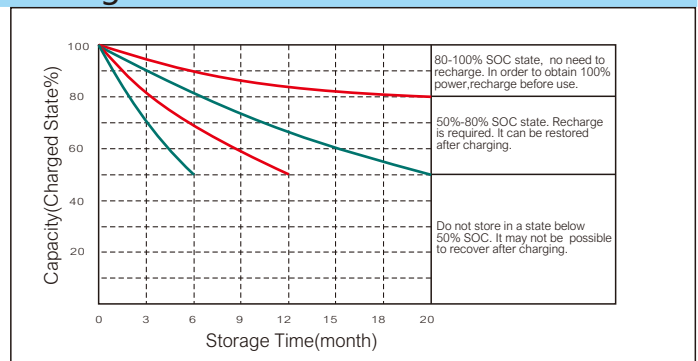

Kaiying Power Supply & Electrical Equip Co., Ltd Email: [sales@longwaybattery.com](mailto:sales@longwaybattery.com)  
 Tel:0595-68782266 Fax:0595-68782222 Website: <http://www.longwaybattery.com>  
 Add: Kaiying Industrial Area, Chengxiang Town, Anxi, Quanzhou, Fujian Province, China  
 KY-IOP-LW6-1.2 B0.May 2023

Note: This information usually describes use only and is not intended to make any warranties or promises regarding the battery, Battery specifications and battery design are subject to change without prior notice. Please contact LONGWAY Battery for the latest information.