



# General VRLA Battery

## FM2500G (2V2500Ah)

The LONGWAY General Series 2V batteries (100-3000Ah) are designed and developed using AGM technology and valve controlled sealing technology. They can meet conventional performance requirements, with a designed float charging life of over 15 years. The valve controlled non-spillable structure design allows safe use in any direction and is certified by sea and air freight. The battery performance also meets international standards, such as IEC60896-2012, UL1989.etc.



### General Feature

- High reliability, safe without leakage, can be used in any position
- Excellent recovery performance after deep discharge
- Environmentally friendly products.  
Meet EU battery directive RoHS and REACH standards
- Maintenance free
- Widely applicable temperature range, can be used at -20 °C~60°C
- Low self-discharge rate. The average monthly self-discharge rate of the battery is less than 2.5%  
(It is recommended to recharge after storage for 6 months or before use)

### Applications

- Electrical power system
- Solar system
- Electrical test equipment
- Telecom & Network Equipment
- UPS, fire alarm & safe-protection
- Emergency lighting device; Alarm system
- Robots and control machines and other

### Performance

|                             |   |
|-----------------------------|---|
| Nominal Voltage             | 2V (1cell)  |
| Capacity                    | @25°C   |
| 10hr Rate (250A)            | 2500Ah @ to 1.75V/cell                                      |
| 5hr Rate (425A)             | 2125Ah @ to 1.70V/cell                                      |
| 3hr Rate (625A)             | 1875Ah @ to 1.60V/cell                                      |
| Weight                      | Approx (118±3%)kg ( 260.1lbs )                              |
| Internal Resistance         | Approx 0.10mΩ fully charged @25°C                           |
| Maximum Discharge Current   | 400A(3sec)  |
| Terminal                    | I7  |
| Operating Temperature Range | Discharge:-20°C~60°C; Charge:0°C~50°C<br>Storage:-20°C~40°C |
| Container Material          | ABS(UL94 HB)/UL94-V0 Optional                               |

### Dimensions

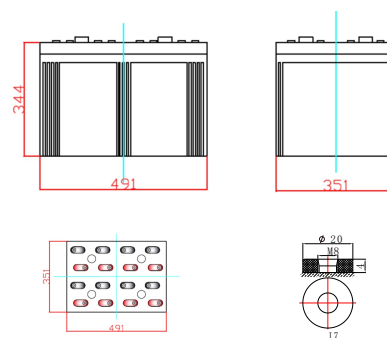

|              |       |          |
|--------------|-------|----------|
| Length       | 491mm | 19.3inch |
| Width        | 351mm | 13.8inch |
| Height       | 344mm | 13.5inch |
| Total height | 383mm | 15.1inch |

### Battery use

#### Cycle use

1. Limit the initial charging current to no more than 500A
2. Keep charging voltage at 2.40-2.50V/unit, and continue charging at least 3 hours after the charging current reduces to 50A to ensure full charge
3. The compensation coefficient of charging voltage and temperature is -5mv/cell /°C

#### Float use

1. Limit the initial charging current to no more than 500A
2. Keep charging voltage at 2.25-2.30V/unit. When the voltage reaches the constant voltage, the current gradually decreases until the battery is fully charged and continues to charge
3. The compensation coefficient of charging voltage and temperature is -3mv/cell /°C



Kaiying Power Supply & Electrical Equip Co., Ltd Email: [sales@longwaybattery.com](mailto:sales@longwaybattery.com)  
 Tel:0595-68782266 Fax:0595-68782222 Website: <http://www.longwaybattery.com>  
 Add: Kaiying Industrial Area, Chengxiang Town, Anxi, Quanzhou, Fujian Province, China  
 KY-IOP-LW2-2500 B0. May 2023

Note: This information usually describes use only and is not intended to make any warranties or promises regarding the battery. Battery specifications and battery design are subject to change without prior notice. Please contact LONGWAY Battery for the latest information.



# General VRLA Battery FM2500G (2V2500Ah)

## Floating Charging Life VS Temperature

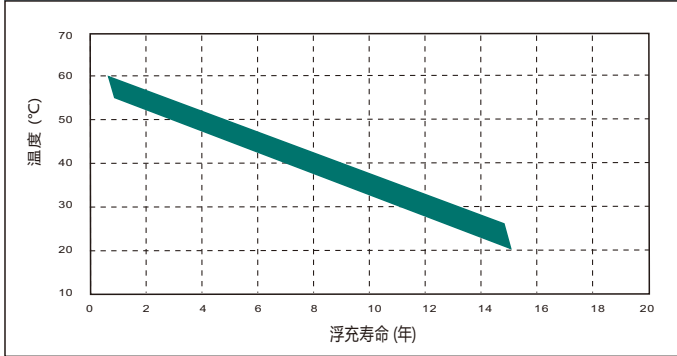

## Floating Charging Characteristics Diagram

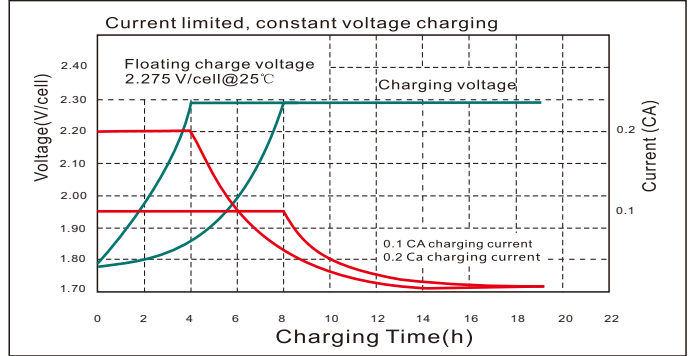

## Cycle Life

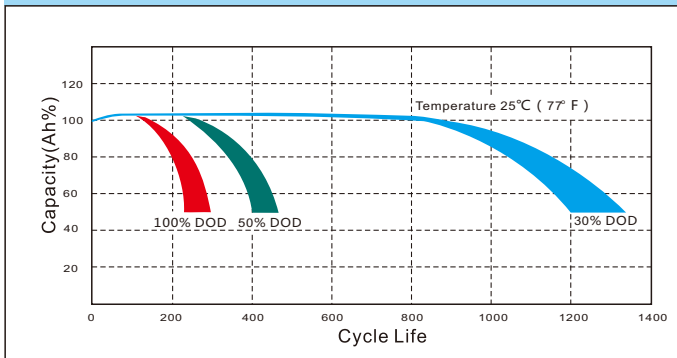

## Cycle charging characteristic diagram

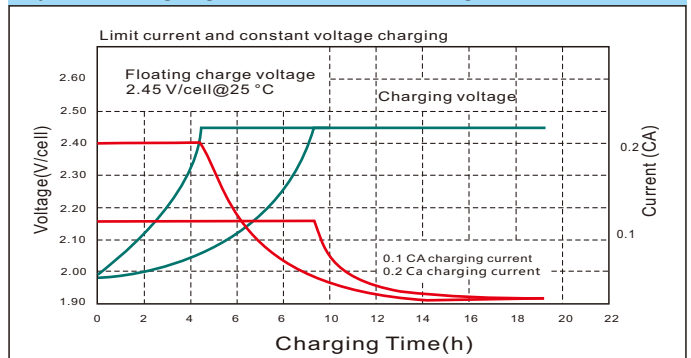

## Temperature and capacity characteristics

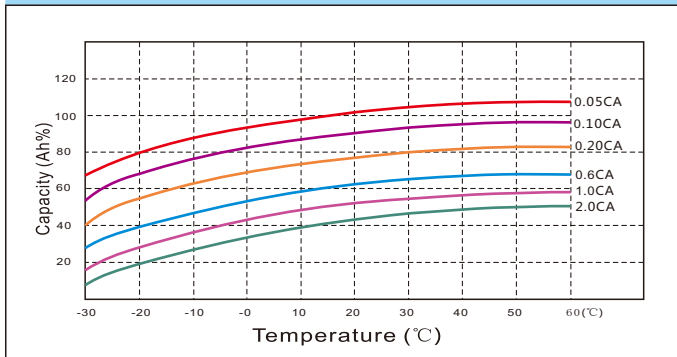

## Self-discharge characteristic

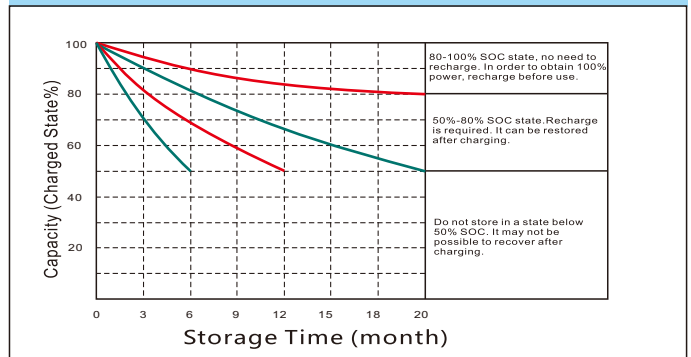

## Constant current characteristics(A,25°C )

| F.V/TIME | 15min | 30min | 60min | 2h    | 3h    | 5h    | 8h    | 10h   | 20h   | 100h  |
|----------|-------|-------|-------|-------|-------|-------|-------|-------|-------|-------|
| 1.60     | 3375  | 2625  | 1400  | 926.2 | 667.4 | 469.4 | 329.9 | 266.4 | 133.2 | 31.72 |
| 1.65     | 3308  | 2573  | 1372  | 921.6 | 664.1 | 467.1 | 328.3 | 265.9 | 133.0 | 31.66 |
| 1.70     | 3240  | 2520  | 1344  | 917.1 | 660.8 | 464.8 | 326.6 | 264.1 | 132.0 | 31.44 |
| 1.75     | 3139  | 2441  | 1302  | 912.5 | 657.5 | 462.5 | 325.0 | 263.3 | 131.6 | 31.34 |
| 1.80     | 3078  | 2394  | 1277  | 894.3 | 644.4 | 453.3 | 308.8 | 262.5 | 131.3 | 31.25 |

## Constant power discharge characteristic ( W,25°C )

| F.V/TIME | 15min | 30min | 60min | 2h   | 3h   | 5h    | 8h    | 10h   | 20h   | 100h  |
|----------|-------|-------|-------|------|------|-------|-------|-------|-------|-------|
| 1.60     | 6075  | 4856  | 2681  | 1704 | 1318 | 934.2 | 658.1 | 532.9 | 266.4 | 63.44 |
| 1.65     | 5954  | 4759  | 2627  | 1696 | 1312 | 929.6 | 654.9 | 531.8 | 265.9 | 63.31 |
| 1.70     | 5832  | 4662  | 2574  | 1687 | 1305 | 925.0 | 651.6 | 528.2 | 264.1 | 62.88 |
| 1.75     | 5650  | 4516  | 2493  | 1679 | 1299 | 920.4 | 648.4 | 526.6 | 263.3 | 62.69 |
| 1.80     | 5540  | 4429  | 2445  | 1645 | 1273 | 902.0 | 616.0 | 525.0 | 262.5 | 62.50 |



Kaiying Power Supply & Electrical Equip Co., Ltd  
Tel:0595-68782266 Fax:0595-68782222  
Add: Kaiying Industrial Area, Chengxiang Town, Anxi, Quanzhou, Fujian Province, China  
KY-IOP-LW2-2500 B0. May 2023

Email: [sales@longwaybattery.com](mailto:sales@longwaybattery.com)

Website: <http://www.longwaybattery.com>

Note: This information usually describes use only and is not intended to make any warranties or promises regarding the battery. Battery specifications and battery design are subject to change without prior notice. Please contact LONGWAY Battery for the latest information.